

Gateway®



User Guide

Gateway 30-inch LCD TV

Contents

1	Introducing Your Gateway LCD TV	1
	Package contents	2
	Features	3
	Front panel controls	4
	Back panel connections	5
	Accessories	6
2	Watching TV	7
	Connecting your satellite set-top box	8
	Using component video	8
	Connecting off-air TV or cable TV	9
	Turning on the power	10
	Watching a TV program	11
3	Connecting Other Components	13
	Understanding video connections	14
	Connecting your DVD player	15
	Using component video	15
	Using S-Video	16
	Using composite video	17
	Connecting your HDTV set-top box	18
	Using component video	18
	Using VGA video	19
	Connecting your VCR or video camera	20
	Using S-Video	20
	Using composite video	21
	Connecting external amplified speakers	22
	Connecting an external receiver or amplifier	23
	Connecting a computer	24
	Using DVI video	24
	Using VGA video	25
4	Adjusting Your LCD TV Settings	27
	Understanding viewing features	28
	Viewing modes	28
	Picture-in-Picture (PIP) mode	29
	Using the on-screen display	31
	OSD menus and options	32
	Using parental controls	36
	Setting parental controls	36
	Setting a password	39

Using key lockout	40
Using IR lockout	41
Setting the sleep timer	41
5 Maintenance and Troubleshooting	43
Important safeguards	44
Cleaning and maintenance	45
Cleaning the screen	45
Cleaning the exterior	46
Troubleshooting	46
Contact Technical Support	48
A Safety, Regulatory, and Legal Information	49
Index	55

Chapter 1

Introducing Your Gateway LCD TV



- Package contents
- Features
- Controls and connections
- Accessories

Package contents

Along with your LCD TV, the packaging box contains the following items:

Remote control and
two AA batteries



Power cord



S-Video cable



Audio cable



LCD TV user guide
and remote control
user guide



Features

Your LCD TV features:

- A bright, flicker-free image
- Automatic conversion of film content for correct display with minimal screen noise
- Accurate color processing
- High-definition component video input that automatically synchronizes the display to match the incoming source
- Picture-in-picture (PIP) mode that lets you watch two programs simultaneously
- HDTV signal compatibility using an external HDTV decoder with VGA, DVI, or component video outputs
- Digital zoom modes get rid of “black bars” around the display image
- Built-in internal amplifier and speakers
- A built-in Digital Visual Interface (DVI) to eliminate the need for digital-to-analog conversion with HDCP.
- 1280 × 768 SXGA support for computer input
- 720p and 1080i support for HDTV signals
- Audio and composite video output that lets you watch a program on a separate television or VCR.

Front panel controls

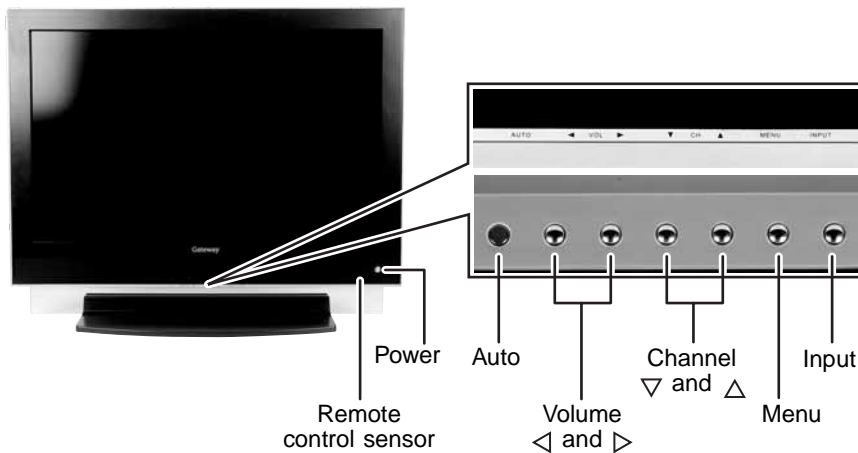

Button	Description
Remote control sensor	Receives signals from the remote control. Do not block.
Power/Status LED	Turns your LCD TV on and off. When you turn your LCD TV on or off, wait three seconds before pressing this button again. <ul style="list-style-type: none"> ▪ Not lit - No AC power detected. The power cord is not connected. ▪ Solid yellow - Your LCD TV is off. ▪ Solid green - Your LCD TV is on.
Auto	Automatically adjusts the display to the best settings in VGA and DVI modes. OSD active: Accepts an on-screen display (OSD) menu item. For more information, see "Using the on-screen display" on page 31.
Volume < and >	Increases or decreases the volume. OSD active: Adjusts on-screen display (OSD) options. For more information, see "Using the on-screen display" on page 31.
Channel < and >	Changes the channel. OSD active: Selects on-screen display (OSD) options. For more information, see "Using the on-screen display" on page 31.
Menu	Opens and closes the on-screen display (OSD).
Input	Switches between available input sources.

Back panel connections

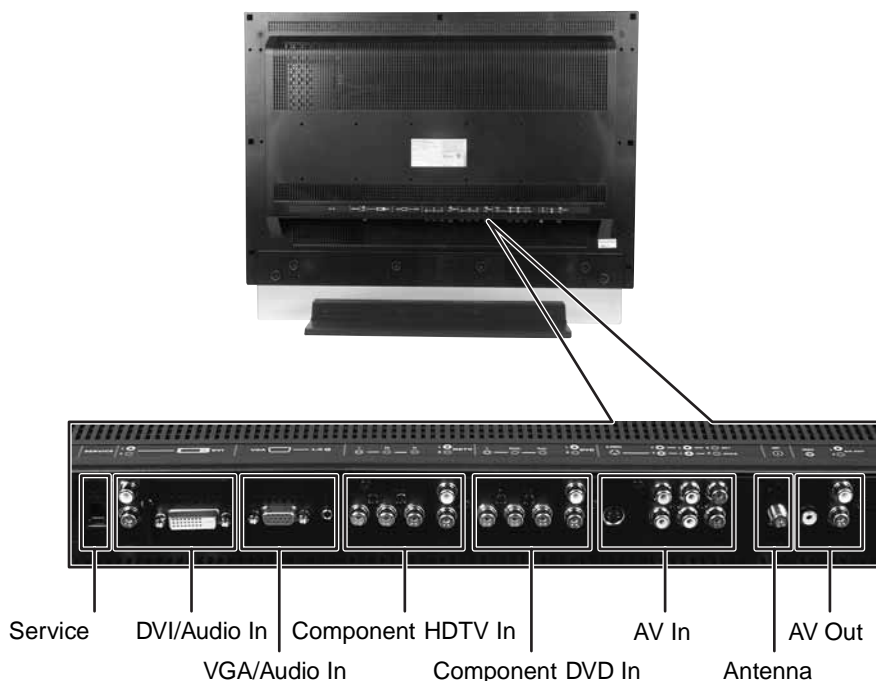

Connector	Description
Service	Connects to a wired remote. For more information, see the documentation on the Gateway Web site at support.gateway.com/support/manlib/ .
DVI/Audio In	Connects to a DVI audio/video device, such as a computer or set-top box.
VGA/Audio In	Connects to a VGA audio/video device, such as a computer or set-top box.
Component HDTV In	Connects to a component audio/video device, such as an HDTV set-top box. (480i, 480p, 720p, and 1080i)
Component DVD In	Connects to a component DVD player. (480i/480p only)
AV In	Connects to two composite or S-Video audio/video devices, such as a VCR.
Antenna	Connects to a VHF/UHF antenna or cable TV.
AV Out	Connects to an audio/video device, such as a receiver or television.

Accessories

You can purchase these optional accessories for your LCD TV:

- **Cable kits.** Gateway cable kits consist of high-quality gold cables of various lengths, including:
 - DVI-D video cable
 - RCA audio cable
 - RCA component video cable
 - RCA composite video cable
 - S-Video cable
 - VGA video cable

Contact Gateway for these and other accessories.

Chapter 2

Watching TV



- Connecting a satellite dish
- Connecting cable TV or an off-air antenna
- Turning on your LCD TV
- Watching a TV program

Connecting your satellite set-top box

Using component video

▶ To connect your satellite set-top box using component video:

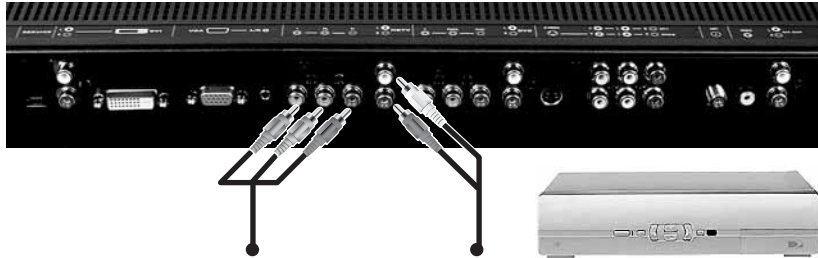

- 1 Make sure that the power button on your LCD TV is turned off.
- 2 Connect the green **Y** jack on the back of your satellite set-top box to the **COMPONENT HDTV green Y** jack on the back of your LCD TV.
- 3 Connect the red **PR** or **CR** jack on the back of your satellite set-top box to the **COMPONENT HDTV red PR/CR** jack on the back of your LCD TV.
- 4 Connect the blue **PB** or **CB** jack on the back of your satellite set-top box to the **COMPONENT HDTV blue PB/CB** jack on the back of your LCD TV.
- 5 Connect the red (R) and white (L) audio jacks on the back of your satellite set-top box to the **COMPONENT HDTV R and L** audio-in jacks on the back of your LCD TV.



Connecting off-air TV or cable TV

- ▶ To connect off-air TV or cable TV using coaxial (RF) audio and video:

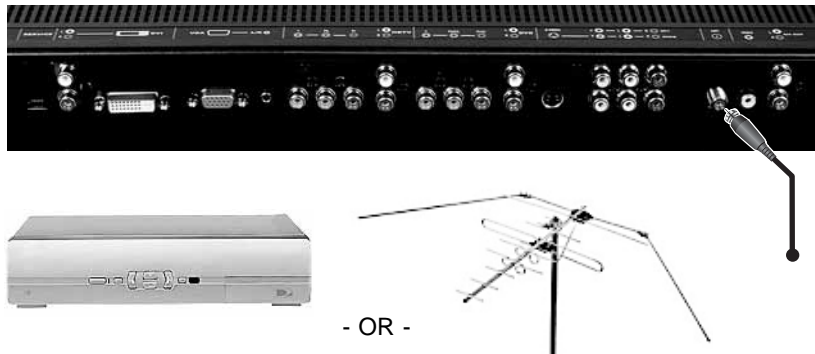

- 1 Make sure that the power button on your LCD TV is turned off.
- 2 Connect the coaxial (RF) connector from your antenna or cable box to the **Ant.** connector on the back of your LCD TV.



If you have connected a VCR to the **Ant.** connector on the back of your LCD TV, connect your off-air TV or cable TV cable to the **Ant.** connector on the back of your VCR.

Warning



If an outdoor antenna or cable system is connected to your LCD TV, make sure that the antenna or cable system is correctly grounded. For more information, see "Television antenna connectors protection (for systems fitted with TV/cable TV tuner cards)" on page 51.

Turning on the power

▶ To turn on the power:

- 1 Connect the power cord to the power cord connector on the back of your LCD TV, then plug the other end of the power cord into a correctly grounded electrical outlet or surge protector.

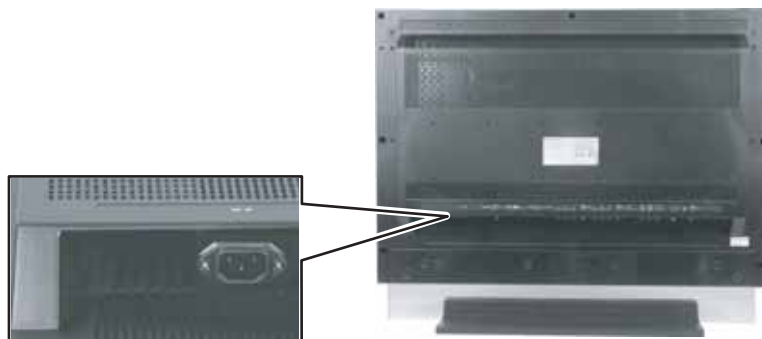

- 2 Press the power button.



Warning



For added protection during a lightning storm or when your LCD TV is left unattended or unused for long periods of time, unplug it from the wall outlet and disconnect the antenna or cable system.

Watching a TV program

To watch a TV program, make sure that:

- All cable, satellite, or off-air antenna connections are secure.
- The power cord is plugged into a correctly grounded electrical outlet or surge protector.

To watch a TV program:

- 1 Press the power button on the front of your LCD TV. The Status LED on the front turns green.
- 2 Select **TV** using the **INPUT** button on the front of your LCD TV if you are watching a cable TV box or off-air antenna.

- OR -

Select **HDTV** using the **INPUT** button on the front of your LCD TV if you are watching your satellite dish.

You should be able to see a picture. If you do not, make sure that all connections are secure and you have selected the correct video input source.

- 3 Press the **CH** ∇ and \triangle buttons on the front of your LCD TV to change the channel.

Important



The **CH** ∇ and \triangle buttons on the front of the television do not work if you are watching a program using HDTV input.



You can also use your remote control to change these settings. For more information, see your remote control user guide.

To make additional adjustments to your LCD TV, see “Adjusting Your LCD TV Settings” on page 27.

Chapter 3

Connecting Other Components



- Connecting DVD players – go to page 15
- Connecting HDTV decoder set-top boxes – go to page 18
- Connecting VCRs and video camcorders – go to page 20
- Connecting external audio devices – go to page 22
- Connecting computers – go to page 24



Understanding video connections

Warning



To prevent electrical shock, unplug your LCD TV before connecting any external components. To restart your LCD TV, see "Turning on the power" on page 10.

Your LCD TV has four types of standard video connections. You should use the best connection available to get the best display. For example, if your DVD player supports a component video connection, connect the DVD player to your LCD TV using component video instead of composite video or S-Video.

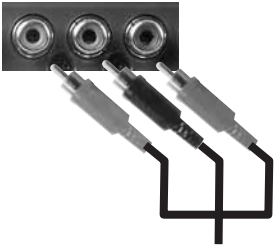
Connection Quality	Cable and Connector	Description
Basic		Coaxial (RF). The video and audio signals are both carried in one cable (the other three connection types only handle video, and require separate connections for sound). Coaxial is the only way to connect an antenna to your LCD TV.
Good		Composite. The video signal is carried through a single "pin." This connection method is the one that is most commonly found on devices.
Better		S-Video. The video signal is split into two signals, black-and-white and color. Text displayed on-screen through this connection will be noticeably sharper than composite or coaxial (RF).
Best		Component. The video signal is split into three signals, two color, and one black-and-white. Use component video to take advantage of the superior picture provided by signal sources as HDTV and DVD.

Connecting your DVD player

Using component video

Important



You can connect 480i (interlaced) and 480p (progressive scan) DVD players in this way. You cannot use 480p as a Picture-in-Picture (PIP) source.

▶ To connect your DVD player using component video:

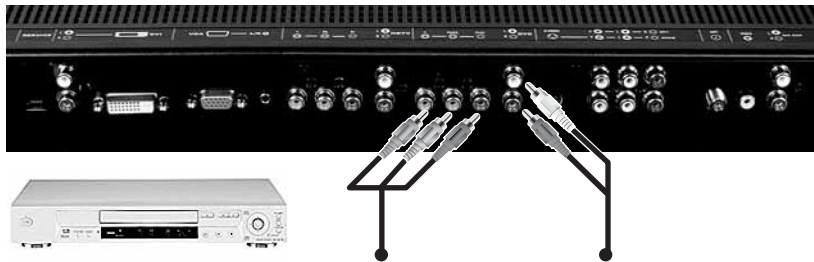

- 1 Make sure that the power button on your LCD TV is turned off.
- 2 Connect the green **Y** jack on the back of your DVD player to the DVD green **Y** jack on the back of your LCD TV.
- 3 Connect the red **P_R** or **C_R** jack on the back of your DVD player to the DVD red **P_R/C_R** jack on the back of your LCD TV.
- 4 Connect the blue **P_B** or **C_B** jack on the back of your DVD player to the DVD blue **P_B/C_B** jack on the back of your LCD TV.
- 5 Connect the red (**R**) and white (**L**) audio jacks on the back of your DVD player to the DVD **R** and **L** audio-in jacks on the back of your LCD TV.
- 6 Restart your LCD TV. See “Turning on the power” on page 10.
- 7 Select **DVD** using the **INPUT** button on the front of your LCD TV.

You should be able to see a picture. If you do not, make sure that all connections are secure and you have selected the correct video input source.



Using S-Video

▶ To connect your DVD player using S-Video:

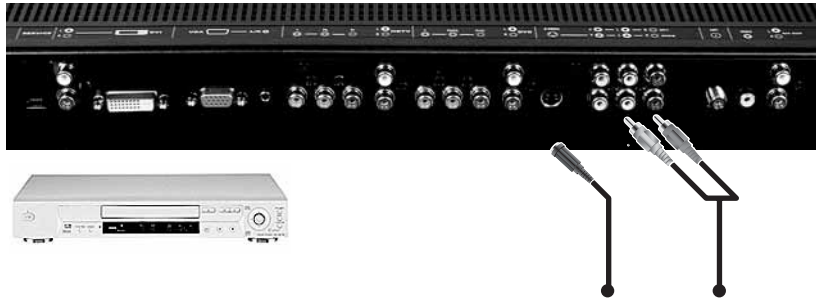

- 1 Make sure that the power button on your LCD TV is turned off.
- 2 Connect the **S-Video** jack on the back of your DVD player to the **AV2/S IN S-VIDEO** jack on the back of your LCD TV.
- 3 Connect the red (**R**) and white (**L**) audio jacks on the back of your DVD player to the **AV2/S IN R** and **L** audio-in jacks on the back of your LCD TV.
- 4 Restart your LCD TV. See “Turning on the power” on page 10.
- 5 Select **AV2/S** using the **INPUT** button on the front of your LCD TV.

You should be able to see a picture. If you do not, make sure that all connections are secure and you have selected the correct video input source.



Using composite video

▶ To connect your DVD player using composite video:

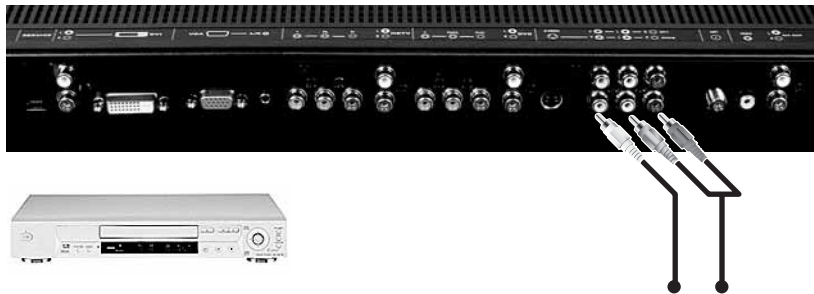

- 1 Make sure that the power button on your LCD TV is turned off.
- 2 Connect the yellow video jack on the back of your DVD player to the yellow **AV1** or **AV2/S IN** jack on the back of your LCD TV.
- 3 Connect the red (**R**) and white (**L**) audio jacks on the back of your DVD player to the **AV1** or **AV2/S IN R** and **L** audio-in jacks on the back of your LCD TV.
- 4 Restart your LCD TV. See “Turning on the power” on page 10.
- 5 Select **AV1** or **AV2/S** using the **INPUT** button on the front of your LCD TV.

You should be able to see a picture. If you do not, make sure that all connections are secure and you have selected the correct video input source.



Connecting your HDTV set-top box

Using component video

Important



You can connect 480i (interlaced), 480p (progressive scan), 720p, and 1080i set-top boxes in this way. You cannot use component video as a Picture-in-Picture (PIP) source.

▶ To connect your HDTV decoder set-top box using component video:

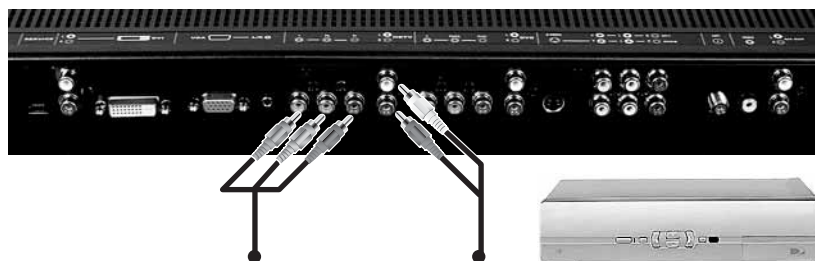

- 1 Make sure that the power button on your LCD TV is turned off.
- 2 Connect the green Y jack on the back of your HDTV set-top box to the HDTV green Y jack on the back of your LCD TV.
- 3 Connect the red **P_R** or **C_R** jack on the back of your HDTV set-top box to the HDTV red **P_R/C_R** jack on the back of your LCD TV.
- 4 Connect the blue **P_B** or **C_B** jack on the back of your HDTV set-top box to the HDTV blue **P_B/C_B** jack on the back of your LCD TV.
- 5 Connect the red (R) and white (L) audio jacks on the back of your HDTV set-top box to the HDTV R and L audio-in jacks on the back of your LCD TV.
- 6 Restart your LCD TV. See “Turning on the power” on page 10.
- 7 Select **HDTV** using the **INPUT** button on the front of your LCD TV.

You should be able to see a picture. If you do not, make sure that all connections are secure and you have selected the correct video input source.



Using VGA video

Important



You cannot use VGA video as a Picture-in-Picture (PIP) source.

For best results, we recommend using the component video connectors for this device. However, if you have already used the component video connectors for other devices, you can connect your HDTV set-top box using **VGA VIDEO**.

▶ To connect your HDTV decoder set-top box using **VGA video**:



- 1 Make sure that the power button on your LCD TV is turned off.
- 2 Connect the 15-pin **D-Sub VGA** jack on the back of your HDTV set-top box to the **VGA VIDEO IN** jack on the back of your LCD TV.
- 3 Connect the red (R) and white (L) audio-out jacks on the back of your HDTV set-top box to the **VGA R/L Audio** jack on the back of your LCD TV using a 1/8-inch stereo plug.
- 4 Restart your LCD TV. See “Turning on the power” on page 10.
- 5 Select **VGA** using the **INPUT** button on the front of your LCD TV.

You should be able to see a picture. If you do not, make sure that all connections are secure and you have selected the correct video input source. Press the **AUTO** button on the front of your LCD TV if necessary.



After you connect your HDTV set-top box to the **VGA** input jack on your LCD TV, you may need to adjust various LCD TV picture settings to correctly match the output from the HDTV set-top box (see “**PICTURE** (for **VGA** and **DVI** inputs)” on page 33).

Connecting your VCR or video camera

Using S-Video

▶ To connect your VCR or video camera using S-Video:

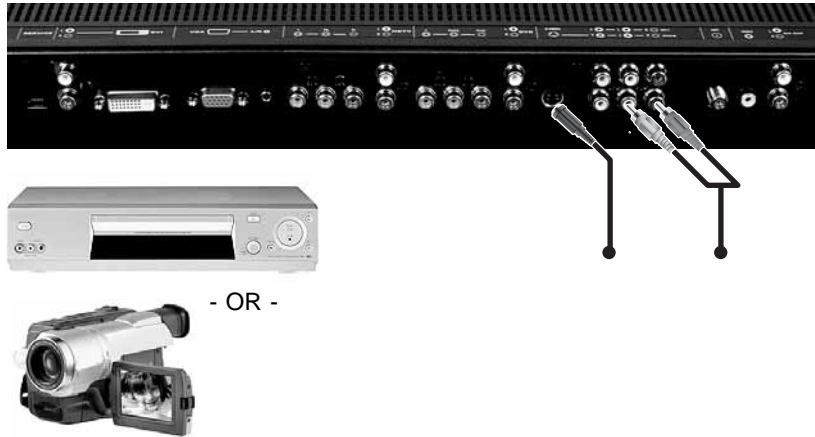

- 1 Make sure that the power button on your LCD TV is turned off.
- 2 Connect the **S-Video** jack on the back of your VCR or video camera to the **AV2/S IN S-VIDEO** jack on the back of your LCD TV.
- 3 Connect the red (**R**) and white (**L**) audio jacks on the back of your VCR or video camera to the **AV2/S IN R** and **L** audio-in jacks on the back of your LCD TV.
- 4 Restart your LCD TV. See “Turning on the power” on page 10.
- 5 Select **AV2/S** using the **INPUT** button on the front of your LCD TV.

You should be able to see a picture. If you do not, make sure that all connections are secure and you have selected the correct video input source.



Using composite video

▶ To connect your VCR or video camera using composite video:

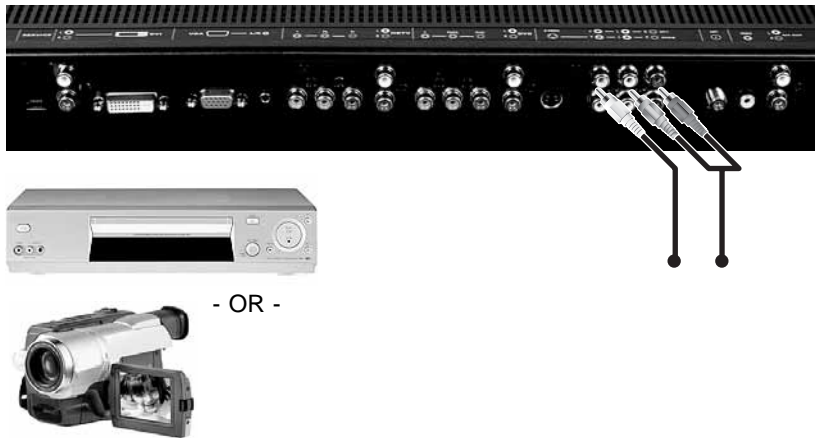

- 1 Make sure that the power button on your LCD TV is turned off.
- 2 Connect the yellow video jack on the back of your VCR or video camera to the yellow **AV1** or **AV2/S IN VIDEO** jack on the back of your LCD TV.
- 3 Connect the red (R) and white (L) audio jacks on the back of your VCR or video camera to the **AV1** or **AV2/S IN R** and **L** audio-in jacks on the back of your LCD TV.
- 4 Restart your LCD TV. See “Turning on the power” on page 10.
- 5 Select **AV1** or **AV2/S** using the **INPUT** button on the front of your LCD TV.

You should be able to see a picture. If you do not, make sure that all connections are secure and you have selected the correct video input source.



Connecting external amplified speakers

You can connect your LCD TV to a set of external, amplified speakers using the AV OUT jacks located on the back of your LCD TV.

Important



The audio is line-out (not variable). It can be muted using the mute function on the remote control.

Important



The audio output through these jacks can be either the Main picture audio or the PIP sub-picture audio. You can set the audio output using the PIP AUDIO button on the remote control.

▶ To connect your external amplified speakers:



- 1 Make sure that the power button on your LCD TV is turned off.
- 2 Connect the red (R) and white (L) audio jacks on the back of your speakers to the AV OUT jacks on the back of your LCD TV.
- 3 Restart your LCD TV. See “Turning on the power” on page 10.



Connecting an external receiver or amplifier

You can connect an external receiver or amplifier to your LCD TV.

Important



The audio is line-out (not variable). It can be muted using the mute function on the remote control.

Important



The audio output through these jacks can be either the Main picture audio or the PIP sub-picture audio. You can set the audio output using the **PIP AUDIO** button on the remote control.

▶ To connect your external receiver or amplifier:



- 1 Make sure that the power button on your LCD TV is turned off.
- 2 Connect the red (R) and white (L) audio jacks on the back of your external amplifier or receiver to the **AV OUT** jacks on the back of your LCD TV.
- 3 Restart your LCD TV. See “Turning on the power” on page 10.



Connecting a computer

Using DVI video

Important



This jack supports HDCP devices such as DVD players and set-top-boxes. You cannot use component video as a Picture-in-Picture (PIP) source.

▶ To connect your computer using DVI video:



- 1 Make sure that the power button on your LCD TV is turned off.
- 2 Connect the **DVI** connector on your computer to the **DVI IN** connector on the back of your LCD TV.
- 3 Connect the **Audio Out** jack on your computer to the **DVI R** and **L** Audio jacks on the back of your LCD TV.
- 4 Restart your LCD TV. See “Turning on the power” on page 10.
- 5 Select **DVI** using the **INPUT** button on the front of your LCD TV.

You should be able to see a picture. If you do not, make sure that all connections are secure and you have selected the correct video input source. Press the **AUTO** button on the front of your LCD TV if necessary.



Using VGA video

Important



You cannot use VGA video as a Picture-in-Picture (PIP) source.

▶ To connect your computer using VGA video:



- 1 Make sure that the power button on your LCD TV is turned off.
- 2 Connect the 15-pin **D-Sub VGA** connector on your computer to the **VGA IN** connector on the back of your LCD TV.
- 3 Connect the **Audio Out** jack on your computer to the **VGA R/L Audio** jack on the back of your LCD TV.
- 4 Restart your LCD TV. See “Turning on the power” on page 10.
- 5 Select **VGA** using the **INPUT** button on the front of your LCD TV.

You should be able to see a picture. If you do not, make sure that all connections are secure and you have selected the correct video input source. Press the **AUTO** button on the front of your LCD TV if necessary.



Chapter 4

Adjusting Your LCD TV Settings



- Viewing modes
- Using Picture-in-Picture (PIP) mode
- Adjusting settings
- Using parental controls
- Setting the sleep timer

Understanding viewing features

Your LCD TV features four viewing modes and Picture-in-Picture (PIP) mode. You can switch viewing modes using the on-screen display (OSD) or the remote control. For more information on using the OSD, see “Using the on-screen display” on page 31. For information about using the remote control, see your remote control user guide.

Important



Viewing mode and volume are saved based on input. For example, you last watched a DVD in widescreen mode and at high volume, and then watched TV in standard mode and low volume. When you switch back to DVD input, the viewing mode will return to widescreen and your volume will be high.

Viewing modes

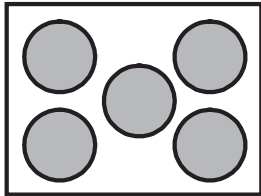
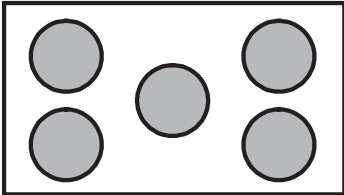
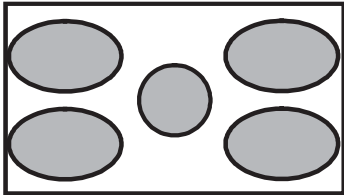
Viewing Mode	Description
	<p>Standard mode. The original 4:3 aspect ratio (1.33:1 source) is preserved, so black bars are added to the left and right of the display image.</p> <p>Standard TV broadcasts are displayed with a 4:3 aspect ratio. Movies in 4:3 may be referred to as pan-and-scan or full frame. These movies were originally filmed in 16:9 (widescreen), then were modified to fit a traditional TV screen (4:3).</p>
	<p>Widescreen mode. When watching a standard broadcast or full-frame movie in this mode, the display image is stretched proportionately to fill the TV screen.</p> <p>When watching a widescreen (1.76:1 source) program or movie the display image fills the TV screen.</p> <p>If you are watching a widescreen (1.85:1 or 2.35:1 source) program or movie, there will still be black bars at the top and bottom.</p>
	<p>Panoramic mode. When watching a standard broadcast or full-frame movie in this mode, the 4:3 aspect ratio (1.33:1 source) display image is stretched horizontally on the left and right sides to fill the TV screen. The center of the image is not stretched.</p>

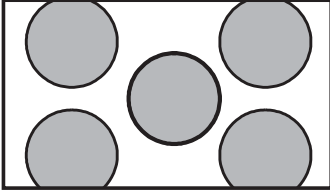
Viewing Mode	Description
	<p>Zoom mode. When watching a widescreen (1.76:1, 1.85:1, or 2.35:1 source) program or movie, the display image is zoomed proportionally to fill the width of the screen. The top and bottom are cut off to remove most of the source material's black bars. This mode is good for programs or movies with subtitles.</p>

Picture-in-Picture (PIP) mode

Your LCD TV features PIP mode so you can watch two pictures at the same time. You can use PIP mode if your PIP video input source is set to TV, AV1, AV2/S, or 480i DVD.

Important



You cannot use HDTV, VGA, DVI, or 480p DVD video as Picture-in-Picture (PIP) sources.

Main Source	Picture-in-Picture Source						
	TV	AV1	AV2/S	DVD	HDTV	VGA	DVI
TV	✓	✓	✓	480i	—	—	—
AV1	✓	✓	✓	480i	—	—	—
AV2/S	✓	✓	✓	480i	—	—	—
DVD	✓	✓	✓	480i	—	—	—
HDTV	✓	✓	✓	480i	—	—	—
VGA	✓	✓	✓	480i	—	—	—
DVI	✓	✓	✓	480i	—	—	—

PIP mode

When PIP is turned on, you can display two pictures at one time. One picture is displayed on the full screen and the other picture is displayed in a small window. The picture on the full screen is the main picture. The picture in the window is the sub-picture. The sub-picture can be set to small, medium, or large.

PIP channel

The PIP channel is independent of the main TV channel.

 To change the PIP channel:

- Press the **PIP CH +** or **-** button on the remote control.



PIP audio

You can listen to either the audio of the program in the main picture or the program in the PIP sub-picture.

 To listen to the audio in the PIP sub-picture:

- Press **PIP AUDIO** on the remote control. Pressing **PIP AUDIO** again will return the audio to the main picture.



Swapping PIP video

You can swap the program that is in the main picture with the program in the PIP sub-picture.

 To swap the main picture program with the PIP sub-picture program:

- Press **SWAP** on the remote control. Pressing **SWAP** again will return the program to the main picture.



Using the on-screen display

Your LCD TV features an on-screen display (OSD) that lets you adjust and save contrast, brightness, and other settings. Your LCD TV saves changes you make to the settings, even if you turn off the television.

▶ To adjust settings from the OSD:

1 Press the **MENU** button on the front of your LCD TV. The OSD opens.

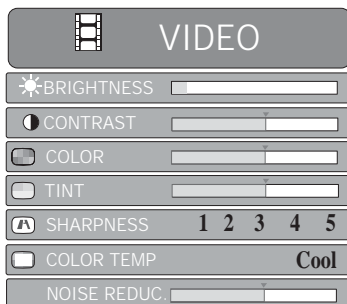

2 Press the **MENU** button on the front of your LCD TV to select the menu you want.

3 Press the **CH** ▾ and ▴ button on the front of your LCD TV to select a menu option.

4 Press the **VOL** ◀ and ▶ button on the front of your LCD TV to adjust the option setting.

5 Press the **MENU** button on the front of your LCD TV repeatedly until the OSD closes.



You can also use your remote control to change some settings. For more information, see your remote control user guide.

OSD menus and options

You can use these OSD menus and options to adjust various settings for your LCD TV.

In the following table, some of the menu options can vary depending on the video input source that you are using. Available video input sources include:

- VGA
- DVI
- HDTV
- DVD
- AV1
- AV2/S
- TV

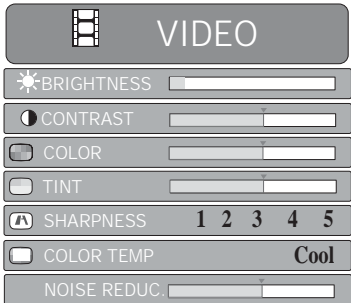
OSD Menu	Description
<p>VIDEO (for AV1, AV2/S, DVD, HDTV, and TV inputs)</p>  <p>The screenshot shows a grey OSD menu titled 'VIDEO'. It contains seven settings, each with a slider or indicator: BRIGHTNESS (sun icon), CONTRAST (circle icon), COLOR (square icon), TINT (square icon), SHARPNESS (triangle icon with values 1-5), COLOR TEMP (square icon with 'Cool' text), and NOISE REDUC. (square icon).</p>	<p>BRIGHTNESS—Adjusts the amount of light in the darkest portion of the picture. Increasing brightness makes the overall picture lighter. Decreasing the brightness makes the overall picture darker.</p> <p>You may need to readjust brightness after the LCD TV warms up.</p> <p>CONTRAST—Adjusts the level of white between the lightest and darkest portions of a image. If the contrast is too low, the picture appears dark and lacks detail. If the contrast is too high, the picture appears faded and lacks shadow and depth.</p> <p>COLOR—Adjusts the levels of white and color in the picture. Highly saturated colors tend to be deep and strong while unsaturated colors are weaker and lighter.</p> <p>TINT—Adjusts the amount of white or black in a color. For example, if the red looks pink, you can adjust the tint to make the red more intense.</p> <p>SHARPNESS—Adjusts the clarity of the picture. If the sharpness is set incorrectly, the picture appears fuzzy or out of focus.</p> <p>COLOR TEMPERATURE—Adjusts the intensity of the colors in the picture. A “cool” or low color temperature is good for watching movies or for watching programs in a darkened environment. A “warm” or high color temperature is good for daylight viewing like sporting events.</p> <p>NOISE REDUCTION (AV1 only)—Eliminates video noise.</p>

OSD Menu

Description

PICTURE (for VGA and DVI inputs)

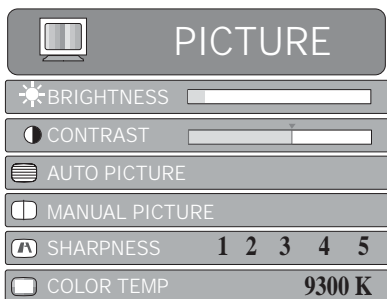

BRIGHTNESS—Adjusts the amount of light in the darkest portion of the picture. Increasing brightness makes the overall picture lighter. Decreasing the brightness makes the overall picture darker.

You may need to readjust brightness after the LCD TV warms up.

CONTRAST—Adjusts the level of white between the lightest and darkest portions of a image. If the contrast is too low, the picture appears dark and lacks detail. If the contrast is too high, the picture appears faded and lacks shadow and depth.

AUTO PICTURE—Automatically sets the position and size of the picture.

MANUAL PICTURE—Manually sets the position and size of the picture. You can also fine tune the picture manually.

SHARPNESS—Adjusts the clarity of the picture. If the sharpness is set incorrectly, the picture appears fuzzy or out of focus.

COLOR TEMPERATURE—Adjusts the intensity of the colors in the picture. A “cool” or low color temperature is good for watching movies or for watching programs in a darkened environment. A “warm” or high color temperature is good for daylight viewing like sporting events.

AUDIO (for all inputs)

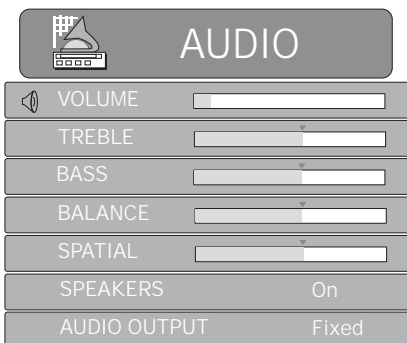

VOLUME—Adjusts the volume.

TREBLE—Adjusts the treble.

BASS—Adjusts the bass.

BALANCE—Adjusts the balance level between the channels.

SPATIAL—Enhances the stereo sound of the built-in speakers.

SPEAKERS—Turns the LCD TV’s internal speakers on or off.

AUDIO OUTPUT—Determines whether the volume can be adjusted using the remote control. If the setting is FIXED, the remote control cannot adjust volume. If the setting is VARIABLE, the remote control can adjust volume.

OSD Menu**Description**

TV (for TV input)

 TV	
SOURCE	Cable
CABLE MODE	Auto
CHANNEL SCAN	
CHANNEL SKIP	Add
CHANNEL FIX	Off
CC MODE	CC1
PARENTAL CONTROLS...	

SOURCE—Sets the source for the tuner.

AIR sets the tuner for an antenna.

CABLE sets the tuner for cable or a satellite dish.

CABLE MODE—Specifies the type of cable system you subscribe to. Options include Standard, HRC, IRC, and Auto. For most cable systems, you can set this value to Auto. However, if you are not receiving all the channels you subscribe to, you may need to set this value.

CHANNEL SCAN—Adds all channels that have a signal to the channel list for access using the **CH** ▾ and ▴ buttons.

CHANNEL SKIP—Specifies the channels that are skipped while pressing the **CH** ▾ and ▴ buttons.

CHANNEL FIX—Sets a channel to use as a single display for external video input, such as for cable box systems or satellite receivers. If this is on, you cannot change the channel using the LCD TV.

CC MODE—Turns captioning on and off and selects the closed caption style.

PARENTAL CONTROLS (blocking)—Activates parental controls. For more information about Parental Controls, see the BLOCKING menu. You need the remote control to use parental controls. For more information, see your remote control user guide.

BLOCKING (for TV input)

BLOCKING	
CHANGE PASSWORD...	
SETUP TV BLOCKING...	
SETUP MOVIE BLOCKING...	
BLOCKING ENABLE	Yes
KEY LOCKOUT	Off
IR LOCKOUT	Off
FACTORY RESET	

CHANGE PASSWORD—Changes the password used for modifying the parental control settings or watching a program blocked by the parental controls. For more information, see “Setting a password” on page 39.

SETUP TV BLOCKING—Sets the level of television shows that will be blocked without typing in the password. For more information, see “Setting parental controls” on page 36.

SETUP MOVIE BLOCKING—Sets the level of movies that will be blocked without typing in the password. For more information, see “Setting parental controls” on page 36.

BLOCKING ENABLE—Turns TV and movie blocking on or off.

KEY LOCKOUT—Locks the LCD TV so it cannot be controlled using the buttons on the front of the TV. For more information, see “Using key lockout” on page 40.

IR LOCKOUT—Locks the LCD TV so it cannot be controlled using the remote control. For more information, see “Using IR lockout” on page 41.

FACTORY RESET—Resets all settings to the factory default.

OSD Menu

Description

SETUP (for all inputs)

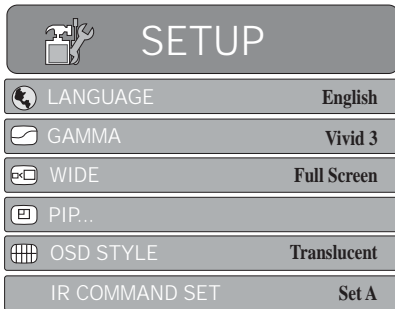

LANGUAGE—Changes the language of the OSD menu.
GAMMA—Changes the color space.
WIDE—Changes the viewing mode. For more information, see “Viewing modes” on page 28.
PIP—Modifies the Picture-in-Picture settings. For more information, see the PiP menu.
OSD STYLE—Switches the OSD background from opaque to translucent.
IR COMMAND SET—Not functional.

PiP

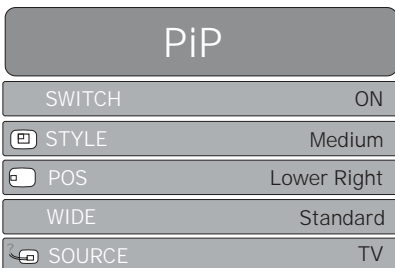

SWITCH—Turns Picture-in-Picture on or off.
STYLE—Changes the size of the PIP sub-picture. Sizes include Small, Medium, and Large.
POS—Moves the sub-picture within the display image.
WIDE—Sets the viewing mode of the PIP sub-picture. Modes include standard and widescreen.
SOURCE—Changes the video input source of the sub-picture when PIP is turned on. Sources include AV1, AV2/S, DVD, and TV.
PIP TV CHANNEL—(TV only, not shown) Changes the PIP channel if the source is set to TV. Use the ◀ and ▶ buttons to change the channel up or down.

Using parental controls

The parental controls feature prevents viewers from watching programs that are not age-appropriate, such as programs containing violence, adult language, or adult themes.

Setting parental controls

▶ To set the parental controls:

- 1 Press the **INPUT** button on the remote or LCD TV until the **TV** input is selected.
- 2 Press the **MENU** button on the remote control until the **TV** menu opens.

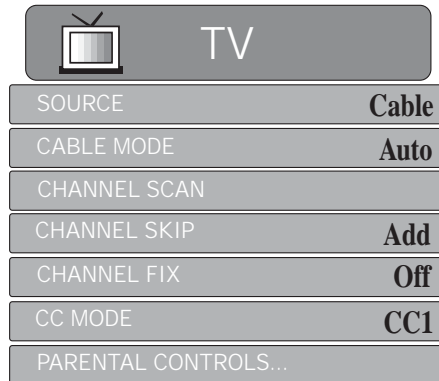

- 3 Press ∇ to highlight **PARENTAL CONTROLS**, then press **OK**. The *Enter Password* window opens.

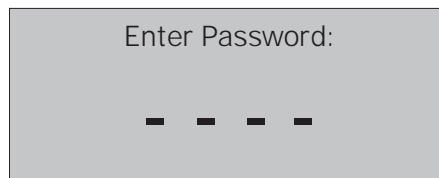

- 4 Use the number pad to type the password, then press **OK**. The password was set to **0000** at the factory. The **BLOCKING** sub-menu opens.

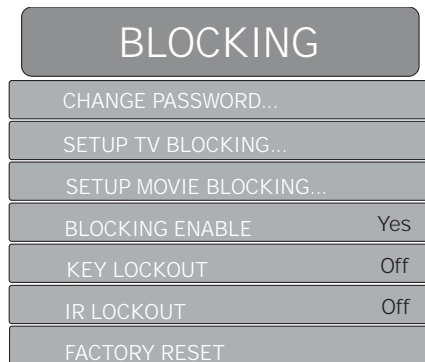

- 5 Press ∇ to highlight **SETUP TV BLOCKING**, then press **OK**. The *TV-Rating* window opens.

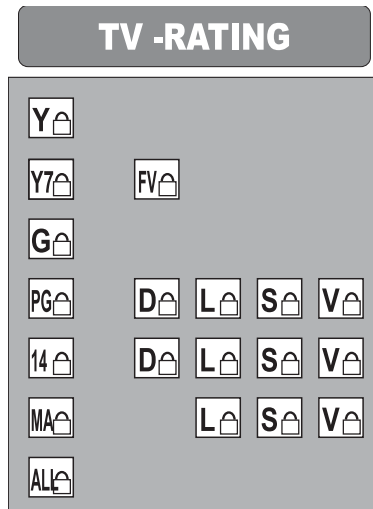

On this window, you can customize the following TV ratings:

- Y (all children)
- Y7 (older children)
- G (general audience)
- PG (guidance suggested)
- 14 (strongly cautioned)
- MA (mature audience)

- 6 Press the \triangle or ∇ to select each rating, then press \triangleleft or \triangleright to toggle the rating to blocked or unblocked.

You can also customize the TV ratings for the following content:

- FV (fantasy violence)
- D (sexual dialog)
- L (adult language)
- S (sexual situations)
- V (violence)

- 7 Press the \triangle or ∇ to select each content, then press \triangleleft or \triangleright to toggle the content to blocked or unblocked.

- 8 Press the **MENU** button on the remote control.

- 9 Press ∇ to highlight **SETUP MOVIE BLOCKING**, then press **OK**. The *MPAA* window opens.

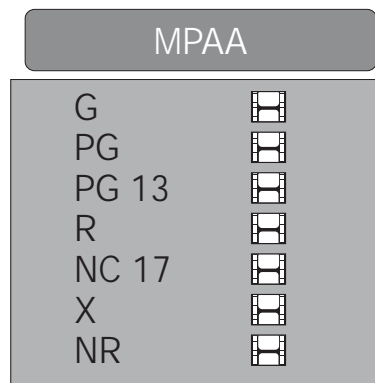

On this menu, you can customize the following MPAA movie ratings:

- G (general audience)
- PG (parental guidance suggested)
- PG-13 (recommended for children 13 years of age or older)
- R (mature audience)
- NC-17 (no one under 17 years of age)
- X (no one under 17 years of age)

- 10 Press the \triangle or ∇ to select each rating, then press \triangleleft or \triangleright to toggle the rating to blocked or unblocked.

- 11 Press the **MENU** button on the remote control.
- 12 Press ∇ to highlight **BLOCKING ENABLE**, then press \triangleleft or \triangleright to toggle the blocking enable to yes.



Setting a password

 To change the parental control password:

- 1 Press the **MENU** button on the remote control until the **TV** menu opens.

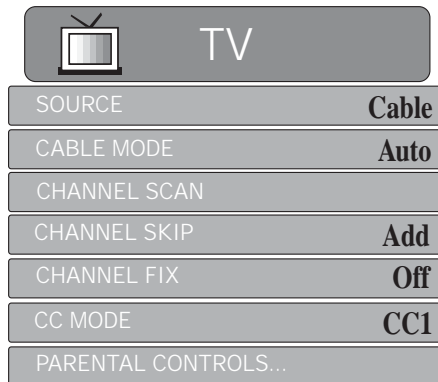

- 2 Press ∇ to highlight **PARENTAL CONTROLS**, then press **OK**. The *Enter Password* window opens.

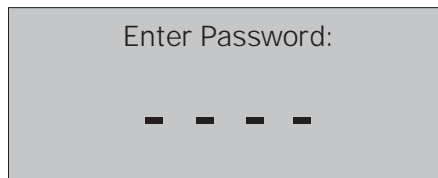

- 3 Use the number pad to type the password, then press **OK**. The password was set to **0000** at the factory. The **BLOCKING** sub-menu opens.

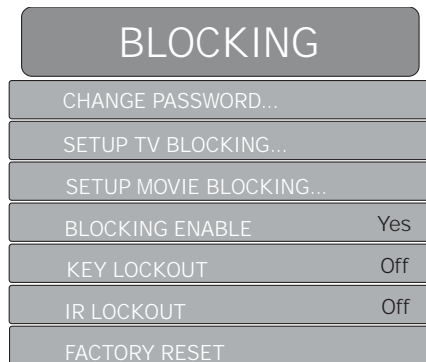

- 4 Highlight **CHANGE PASSWORD**, then press **OK**. The *Change Password* window opens.

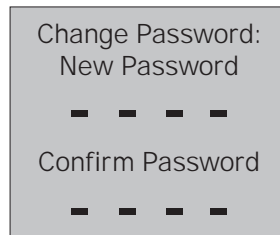

- 5 Use the number pad to type the new four-digit password.
- 6 Use the number pad to retype the new four-digit password.



Using key lockout

Key lockout lets you lock the buttons on the LCD TV so that someone must use the remote control to control the television. Options include **Lock All**, **Lock None**, **Lock All But Power**, and **Off**. For more information, see “BLOCKING (for TV input)” on page 34.

Using IR lockout

IR lockout lets you lock the television so that someone must use the buttons on the LCD TV to control the television. For more information, see “BLOCKING (for TV input)” on page 34.

Important



If you set key lockout, and then set IR lockout without turning off key lockout, the television will continue to run. You will not be able to use either the buttons on the television or the remote control to control the television unless you complete a master unlock. For more information, see “The buttons on the remote control and the buttons on the television do not work” on page 48.

Setting the sleep timer

The sleep timer lets you set a time delay to turn off your LCD TV automatically.



To set the sleep time using the remote control:

- 1 Press the **TV** component button.
- 2 Press the **SLEEP** button on the remote control. The sleep timer appears in the center of your screen.
- 3 Press the **SLEEP** button one or more times to select the time you want.
- 4 Press the **EXIT** button to hide the sleep timer display. Your sleep timer is now running in the background.



To turn off the sleep time using the remote control:

- Press the **SLEEP** button repeatedly until **Off** appears.



Chapter 5

Maintenance and Troubleshooting



- Important safeguards
- Cleaning your LCD TV
- Troubleshooting tips

Important safeguards

Warning



Risk of electric shock - Do not open

To reduce the risk of electric shock, do not remove the back cover. There are no user-serviceable parts inside. Removing the back cover voids the warranty.

Have your LCD TV repaired by qualified service personnel only.

Warnings and precautions

- Do not place your hands, face, or objects close to the ventilation openings of your LCD TV. The top of your LCD TV gets very hot from exhaust air that is released through the ventilation openings. Burns or personal injuries may occur if you are too close to the LCD TV. Damage may occur if you place any object near the top of your LCD TV.
- Disconnect all cables before moving your LCD TV. Moving your LCD TV with its cables attached may damage the cables and cause fire or electric shock danger.
- Do not expose your LCD TV to rain or moisture.
- Keep your LCD TV away from excessive dust, high temperatures, moisture, or direct sunlight.
- Use your LCD TV in a well-ventilated area and do not cover the ventilation openings.
- Do not modify your LCD TV or use an unshielded power cord or video input source cable, or you may experience excessive interference.
- Disconnect your LCD TV and unplug the power cord when not used for a long period of time.
- If the picture displayed is in any way abnormal, turn off your LCD TV, then disconnect it from the electrical outlet. Make sure that your video input source cable is connected correctly, then reconnect your LCD TV to the electrical outlet.
- Disconnect your LCD TV from the electrical outlet before cleaning or performing maintenance. Do not use liquid or aerosol cleaners. Use only a slightly damp cloth for cleaning.
- Do not place your LCD TV on an unstable cart, stand, or table. Your LCD TV may fall, causing serious damage.
- Do not place your LCD TV on a bed, sofa, rug, or other similar surfaces.
- Never place your LCD TV near or over a radiator or heat source.
- Do not install your LCD TV in an enclosed area unless correct ventilation is provided.
- Your LCD TV should be operated from the type of power source indicated on the label. If the type of available power is unknown, consult your electrician or local power company.

- Your LCD TV is equipped with a 3-pin grounded plug. The plug will only fit into a grounded power outlet. This is a safety feature. If you cannot plug the power cord into the outlet, contact your electrician. Do not alter the plug because this will defeat the safety feature.
- Do not rest objects on the power cord and avoid placing the power cord near high traffic areas.
- Do not overload wall outlets and extension cords because this can result in a risk of fire or electric shock.
- Unplug your LCD TV and contact qualified service personnel if:
 - The power cord or plug is damaged or frayed.
 - Liquid has been spilled into your LCD TV.
 - Your LCD TV has been exposed to water or moisture.
 - Your LCD TV does not operate normally when the operating instructions are followed. Adjust only those controls that are covered by the operating instructions. Incorrect adjustment of other controls may result in damage which often requires extensive work by a qualified technician to restore your LCD TV to normal operation.
 - Your LCD TV has been dropped or the cabinet has been damaged.

Cleaning and maintenance

Cleaning the screen

- Do not use substances such as glass cleaners, solvents, and thinners.
- The screen of your LCD TV has been specially treated. Wipe the surface gently using only a cleaning cloth or a soft, lint-free cloth.
- If the surface is particularly dirty, use a soft cloth and water to clean the screen. Squirt a little water on the cloth (never directly on the screen), then wipe the screen with the cloth.

Warning



The screen of your LCD TV is made of specially coated glass and can be scratched or damaged by abrasive or ammonia-based window cleaners.

Scratches on the bezel or glass are not covered by your warranty.

- Do not scratch or hit the surface of the screen with your fingers or any hard objects.

Cleaning the exterior

- Your LCD TV is cooled by air circulated through the vents on the case, so keep the vents free of dust. With your LCD TV turned off and unplugged, brush the dust away from the vents with a damp cloth. Be careful not to drip any water into the vents. Do not attempt to clean dust from the inside of your LCD TV.
- Do not use abrasive or solvent cleaners because they can damage the finish on components.
- Do not allow any excessive water or moisture to come into contact with the surface of your LCD TV. If water or moisture gets inside your LCD TV, operating problems and electrical and shock hazards may result.
- Do not scratch or hit the cabinet with your fingers or any hard objects.
- Do not place articles made from rubber or PVC near the cabinet for any extended periods of time.

Troubleshooting

Use the following information to solve common problems.

You cannot see a picture

- Make sure that the power cord is plugged into a grounded electrical outlet.
- Make sure that the power button is turned on.
- Make sure that the selected input source is connected to a working input source.
- If your LCD TV is connected to your computer in VGA or DVI mode, press any key on your keyboard to “wake” your computer.
- Press the **AUTO** button on the front of your LCD TV if you are using VGA or DVI input.

You see a distorted picture or hear unusual sound

- You may be getting interference from electrical appliances, cars, motorcycles, or fluorescent lights. Try moving your LCD TV to another location.

The color is abnormal

- Make sure that the input source cable is connected securely and correctly to the back of your LCD TV.

The picture has abnormal patterns

- Make sure that the input source cable is attached securely and correctly to the back of your LCD TV.

- Make sure that the video input source is within the range of your LCD TV. Compare the video input source's specifications with your LCD TV specifications.

The display image does not cover the entire screen

- If you are using VGA mode, make sure that **H Size** and **V Position** in the OSD are set correctly.
- If you are using TV, AV1, AV2/S, or component (DVD or HDTV) with 480i input, use the **WIDE** button on the remote control to scroll through various screen modes.

You can see a picture but you cannot hear sound

- Make sure that the volume is not turned down.
- Make sure that the sound is not muted.
- Make sure that your audio input source cables are connected securely and correctly.

The LCD TV has pixels that are always bright, dark, or colored

- Your LCD TV is manufactured using an extremely high level of precision technology. However, sometimes some pixels of your LCD TV may not display. Pixel defects within industry specifications are inherent to this type of product and do not constitute a defective product.

You see "noise" or "trash" on the screen

- When your LCD TV's digital capabilities exceed a digital broadcast signal, the signal is up-converted (increased) to match your LCD TV's display capabilities. Up-converting can cause noise or trash.

Screen brightness is diminished

- Video display devices experience degradation of brightness over the life of the device. Normal brightness degradation is not covered by your warranty.

You switch to a different input and the volume changes

- The LCD TV remembers the volume level from the last time you used a particular input (AV1, AV2/S, DVD, HDTV, TV).

You switch to a different input and the screen size changes

- The LCD TV remembers the viewing mode from the last time you used a particular input (AV1, AV2/S, DVD, HDTV, TV).

The PIP input is set to DVD but the picture does not look correct

- The PIP DVD source must be 480i (interlaced) and not 480p (progressive scan). Set your DVD player to interlaced or choose a different PIP source.

The buttons on the remote control and the buttons on the television do not work

- You may have set both key lockout and IR lockout on the television.

▶ To complete a master unlock of the television:

- 1 Remove the power cord from the wall outlet.
- 2 While pressing and holding the **CH** \triangle , **VOL** \triangleright , and **MENU** buttons on your television at the same time, plug the power cord back into the wall outlet. Both the key lockout and IR lockout are turned off.



The LCD TV will not accept the parental control password

▶ To reset the parental control password:

- 1 Use the remote control to access the *Parental Controls* OSD menu. When prompted for the password, use **0317**.
- 2 Set the password using the steps in “Setting a password” on page 39.



Contact Technical Support

If this troubleshooting information does not resolve your problem, or if you have other questions relating to your LCD TV, go to Gateway's Technical Support Web site at support.gateway.com/support/default.asp.

Appendix A

Safety, Regulatory, and Legal Information



- Safety information
- Regulatory statements
- Notices

Regulatory compliance statements

United States of America

Federal Communications Commission (FCC) Unintentional emitter per FCC Part 15

This device has been tested and found to comply with the limits for a Class B digital device, pursuant to Part 15 of the FCC rules. These limits are designed to provide reasonable protection against harmful interference in a residential installation.

This equipment generates, uses, and can radiate radio frequency energy and, if not installed and used in accordance with the instructions, may cause harmful interference to radio or television reception. However, there is no guarantee that interference will not occur in a particular installation. If this equipment does cause interference to radio and television reception, which can be determined by turning the equipment off and on, the user is encouraged to try to correct the interference by one or more of the following measures:

- Reorient or relocate the receiving antenna
- Increase the separation between the equipment and receiver
- Connect the equipment to an outlet on a different circuit from that to which the receiver is connected
- Consult the dealer or an experienced radio/TV technician for help.

Compliance Accessories: The accessories associated with this equipment are: shielded video cable when an external monitor is connected. These accessories are required to be used in order to ensure compliance with FCC rules.

FCC declaration of conformity

Responsible party:

Gateway, Inc.
14350 Myford Road
Irvine, CA 92606 USA

Product:

- SHD-3010

This device complies with Part 15 of the FCC Rules. Operation of this product is subject to the following two conditions: (1) this device may not cause harmful interference, and (2) this device must accept any interference received, including interference that may cause undesired operation.

Caution



Changes or modifications not expressly approved by Gateway could void the FCC compliance and negate your authority to operate the product.

California Proposition 65 Warning

Warning



This product contains chemicals, including lead, known to the State of California to cause cancer, birth defects or reproductive harm.

Canada

Industry Canada (IC) Unintentional emitter per ICES-003

This digital apparatus does not exceed the Class B limits for radio noise emissions from digital apparatus as set out in the radio interference regulations of Industry Canada.

Le présent appareil numérique n'émet pas de bruits radioélectriques dépassant les limites applicables aux appareils numériques de Classe B prescrites dans le règlement sur le brouillage radioélectrique édicté par Industrie Canada.

Laser safety statement

All Gateway systems equipped with CD and DVD drives comply with the appropriate safety standards, including IEC 825. The laser devices in these components are classified as "Class 1 Laser Products" under a US Department of Health and Human Services (DHHS) Radiation Performance Standard. Should the unit ever need servicing, contact an authorized service location.

Warning



Use of controls or adjustments or performance of procedures other than those specified in this manual may result in hazardous radiation exposure. To prevent exposure to laser beams, do not try to open the enclosure of a CD or DVD drive.

Television antenna connectors protection (for systems fitted with TV/cable TV tuner cards)

External television antenna grounding

If an outside antenna or cable system is to be connected to your Gateway PC, make sure that the antenna or cable system is electrically grounded to provide some protection against voltage surges and static charges.

Article 810 of the National Electrical Code, ANSI/NFPA 70, provides information with regard to proper grounding of the mast and supporting structure, grounding of the lead-in wire to an antenna discharge unit, size of grounding conductors, location of antenna discharge unit, connection to grounding electrodes, and requirements for the grounding electrode.

Lightning protection

For added protection of any Gateway product during a lightning storm or when it is left unattended or unused for long periods of time, unplug the product from the wall outlet and disconnect the antenna or cable system.

Power lines

Do not locate the antenna near overhead light or power circuits, or where it could fall into such power lines or circuits.

Warning



When installing or realigning an outside antenna system, extreme care should be taken to keep from touching such power lines or circuits. Contact with them could be fatal.

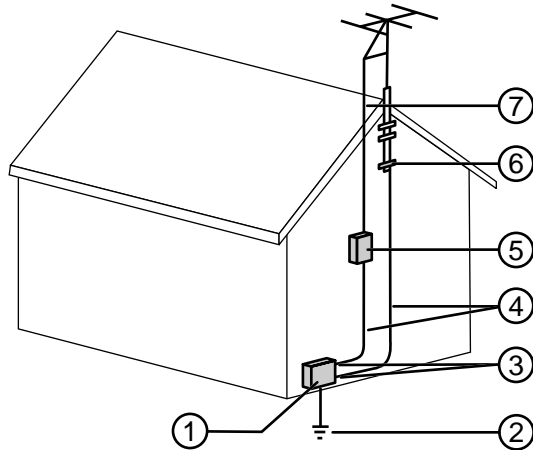

Antenna and satellite grounding

Reference	Grounding component
1	Electric service equipment
2	Power service grounding electrode system (NEC Art 250, Part H)
3	Ground clamps
4	Grounding conductors (NEC Section 810-21)
5	Antenna discharge unit (NEC Section 810-20)
6	Ground clamp
7	Antenna lead-in wire

Notices

Copyright © 2004 Gateway, Inc.
All Rights Reserved
14350 Myford Road
Irvine, CA 92606 USA

All Rights Reserved

This publication is protected by copyright and all rights are reserved. No part of it may be reproduced or transmitted by any means or in any form, without prior consent in writing from Gateway.

The information in this manual has been carefully checked and is believed to be accurate. However, changes are made periodically. These changes are incorporated in newer publication editions. Gateway may improve and/or change products described in this publication at any time. Due to continuing system improvements, Gateway is not responsible for inaccurate information which may appear in this manual. For the latest product updates, consult the Gateway Web site at www.gateway.com. In no event will Gateway be liable for direct, indirect, special, exemplary, incidental, or consequential damages resulting from any defect or omission in this manual, even if advised of the possibility of such damages.

In the interest of continued product development, Gateway reserves the right to make improvements in this manual and the products it describes at any time, without notices or obligation.

Trademark Acknowledgments

Gateway and the Black-and-White Spot Design are trademarks or registered trademarks of Gateway, Inc. in the U.S. and other countries. SpotShop, Spotshop.com, and Your:)Ware are trademarks of Gateway, Inc. Intel, Intel Inside logo, and Pentium are registered trademarks and MMX is a trademark of Intel Corporation. Microsoft, MS, MS-DOS, and Windows are trademarks or registered trademarks of Microsoft Corporation. All other product names mentioned herein are used for identification purposes only, and may be the trademarks or registered trademarks of their respective companies.

Index

Numerics

16:9 mode 28

4:3 mode 28

A

accessories 6

adjust

audi output 33

auto picture 33

balance 33

bass 33

blocking enable 34

brightness 32, 33

cable mode 34

CC mode 34

change password 34

channel fix 34

channel scan 34

channel skip 34

closed caption mode 34

color 32

color temperature 32, 33

contrast 32, 33

factory reset 34

gamma 35

IR lockout 34

key lockout 34

language 35

manual picture 33

noise reduction 32

OSD style 35

parental controls 34

PIP 35

PIP TV channel 35

POS 35

set up movie blocking 34

set up TV blocking 34

sharpness 32, 33

sound 33

source 34, 35

spatial 33

speakers 33

style 35

switch (PIP) 35

tint 32

treble 33

TV settings 32

volume 33

wide 35

amplified speakers

connecting 22

amplifier

connecting 23

antenna connection 5

audio cable 2

audio out connection 5

audio output 33

auto picture 33

B

back panel connections 5

balance 33

bass 33

batteries 2

blocking enable 34

brightness 32, 33

C

cable kits 6

cable mode 34

cable TV

connecting coaxial (RF) 9

CC mode 34

change password 34

channel button 4

channel fix 34

channel scan 34

channel skip 34

cleaning 45

exterior 46

screen 45

closed caption mode 34

coaxial (RF) video 14

color 32

color temperature 32, 33

component video 14

Component Video/Audio In 1 connection 5
Component Video/Audio In 2 connection 5
composite video 14
 connection 5

computer

 connecting DVI video 24
 connecting VGA video 25

connecting

 amplifier 23
 cable TV 9
 computer 24
 DVD player 15
 external amplified speakers 22
 external receiver 23
 HDTV decoder set-top box 18
 off-air TV 9
 power cord 10
 satellite set-top box 8
 VCR 20
 video camera 20

connections

 audio out 5
 AV1 5
 back panel 5
 Component Video 2 5
 Component Video/Audio In 1 5
 composite video 5
 DVI audio in 5
 DVI video in 5
 S-Video 5
 TV In 5
 VGA audio in 5
 VGA video in 5

contrast 32, 33

D

display mode 29
 PIP 29

down button 4, 11, 31, 34

DVD player

 connecting component video 15
 connecting composite video 17
 connecting S-Video 16

DVI

 audio in connection 5
 video in connection 5

E

external amplified speakers
 connecting 22
external receiver
 connecting 23

F

factory reset 34
features 3
front panel buttons 4

G

gamma 35

H

HDTV decoder set-top box
 connecting component video 18
 connecting VGA video 19

I

Input button 4
IR lockout 34, 48

K

key lockout 34, 48

L

language 35
left button 4, 31

M

maintenance 43, 45
manual picture 33
Menu button 4, 31
modes

 display 29
 viewing 28

N

noise reduction 32

O

off-air TV
 connecting coaxial (RF) 9
on-screen display
 see OSD

- OSD 31
 - audio menu 33
 - audio output 33
 - auto picture 33
 - balance 33
 - bass 33
 - blocking enable 34
 - brightness 32, 33
 - cable mode 34
 - CC mode 34
 - change password 34
 - channel fix 34
 - channel scan 34
 - channel skip 34
 - closed caption mode 34
 - color 32
 - color temperature 32, 33
 - contrast 32, 33
 - factory reset 34
 - gamma 35
 - IR lockout 34
 - key lockout 34
 - language 35
 - manual picture 33
 - noise reduction 32
 - OSD style 35
 - parental controls 34
 - Parental controls menu 34, 35
 - picture menu 33
 - PIP 35
 - PIP TV channel 35
 - POS 35
 - set up TV blocking 34
 - setting up
 - movie blocking 34
 - setup menu 35
 - sharpness 32, 33
 - source 34, 35
 - spatial 33
 - speakers 33
 - style 35
 - switch (PIP) 35
 - tint 32
 - treble 33
 - TV menu 34
 - video menu 32
 - volume 33
 - wide 35
- OSD style 35
- P**
 - Panorama mode 28
 - parental controls 34
 - PIP 35
 - PIP mode 29
 - PIP TV channel 35
 - POS 35
 - power
 - button 4
 - turning on 10
 - power cord 2
 - connection 10
- R**
 - receiver
 - connecting 23
 - remote control 2
 - sensor 4
 - user guide 2
 - right button 4, 31, 48
- S**
 - safety 44
 - satellite set-top box
 - connecting component video 8
 - setting up
 - movie blocking 34
 - safety precautions 44
 - TV blocking 34
 - sharpness 32, 33
 - source 34, 35
 - spatial 33
 - speakers 33
 - status LED 4
 - style 35
 - support 48
 - S-Video 14
 - S-Video cable 2
 - switch (PIP) 35
- T**
 - tint 32

treble 33
troubleshooting 43, 46

U

up button 4, 11, 31, 34, 48

V

VCR

- connecting composite video 21
- connecting S-Video 20

VGA

- audio in connection 5
- video in connection 5

Video 1 connection 5

video camera

- connecting composite video 21
- connecting S-Video 20

video connections

- types of 14

viewing mode 28

- 16:9 28

- 4:3 28

- Panorama 28

- Zoom 1 29

volume 33

volume button 4

W

wide 35

Z

Zoom 1 mode 29



MAN 30"LCD TV USR GDE R1 12/04



Free Manuals Download Website

<http://myh66.com>

<http://usermanuals.us>

<http://www.somanuals.com>

<http://www.4manuals.cc>

<http://www.manual-lib.com>

<http://www.404manual.com>

<http://www.luxmanual.com>

<http://aubethermostatmanual.com>

Golf course search by state

<http://golfingnear.com>

Email search by domain

<http://emailbydomain.com>

Auto manuals search

<http://auto.somanuals.com>

TV manuals search

<http://tv.somanuals.com>